



# **FEDERATION INTERNATIONALE DE TIR AUX ARMES SPORTIVES DE CHASSE**

10, rue Médéric - 75017 PARIS FRANCE Phone : (33) 1 42 93 40 53 Fax : (33) 1 42 93 58 22  
e-mail : [fitasc@fitasc.com](mailto:fitasc@fitasc.com) / Site: <http://www.fitasc.com>

## **INTERNATIONAL RULES HELICES ZZ**

**FITASC is the owner of all the rights to the Helice ZZ discipline  
that it created in 1963**

01/01/2024

# INTERNATIONAL RULES – HELICES ZZ

In case of controversial interpretation of the present regulation, the text written in French will make faith.

The present regulation is obligatory during all national and international competitions.

Any person participating to the shooting is required to know perfectly the regulations and to submit without reserve to all dispositions and consequences that may result of it.

## 1 SHOOTING FACILITIES

### 1.1 Range

The helice ZZ shooting range has to be located on a flat field. The general orientation of the stand will be the NORTH or the NORTH EAST and will be represented by an axis going through shooting stand and the machine number three.

- Five (5) machines will have to be positioned 3.80 m minimum and 5.00 m maximum away from each other.
- seven (7) machines will have to be positioned 2.25 m minimum and 2,50 m maximum away from each other, both extra machines being positioned equidistant between machines 2 and 3, then between machines 3 and 4.
- Nine (9) machines will have to be positioned 2.25 m minimum and 2.50 m maximum away from each other, the 4 extra machines being positioned equidistant between machines 1 and 2, between machines 2 and 3, between machines 3 and 4, then between machines 4 and 5.

The stand has to be enclosed by a rigid barrier from 0.60 m to 0.80 m maximum height, whose lattice will be small enough to prevent the passage of the white part of the helice - the distance between the starting point of helices and the barrier has to be 21 meters maximum.

For all the new helice ZZ stands, the distance included between the barrier and the departure point of the helices shall not be less than 21 meters +/- 5%.

The shooting stand is graduated from 24 to 30 m.

Two “Safety Flags” will indicate the limit of the shooting area.

A third “Safety Flag” will be installed in the ranges with “Manual Machines”. This flag will indicate the “Safety zone” for the “Runners”.

# HELICE ZZ SHOOTING LAYOUT (International regulation sizes sample)

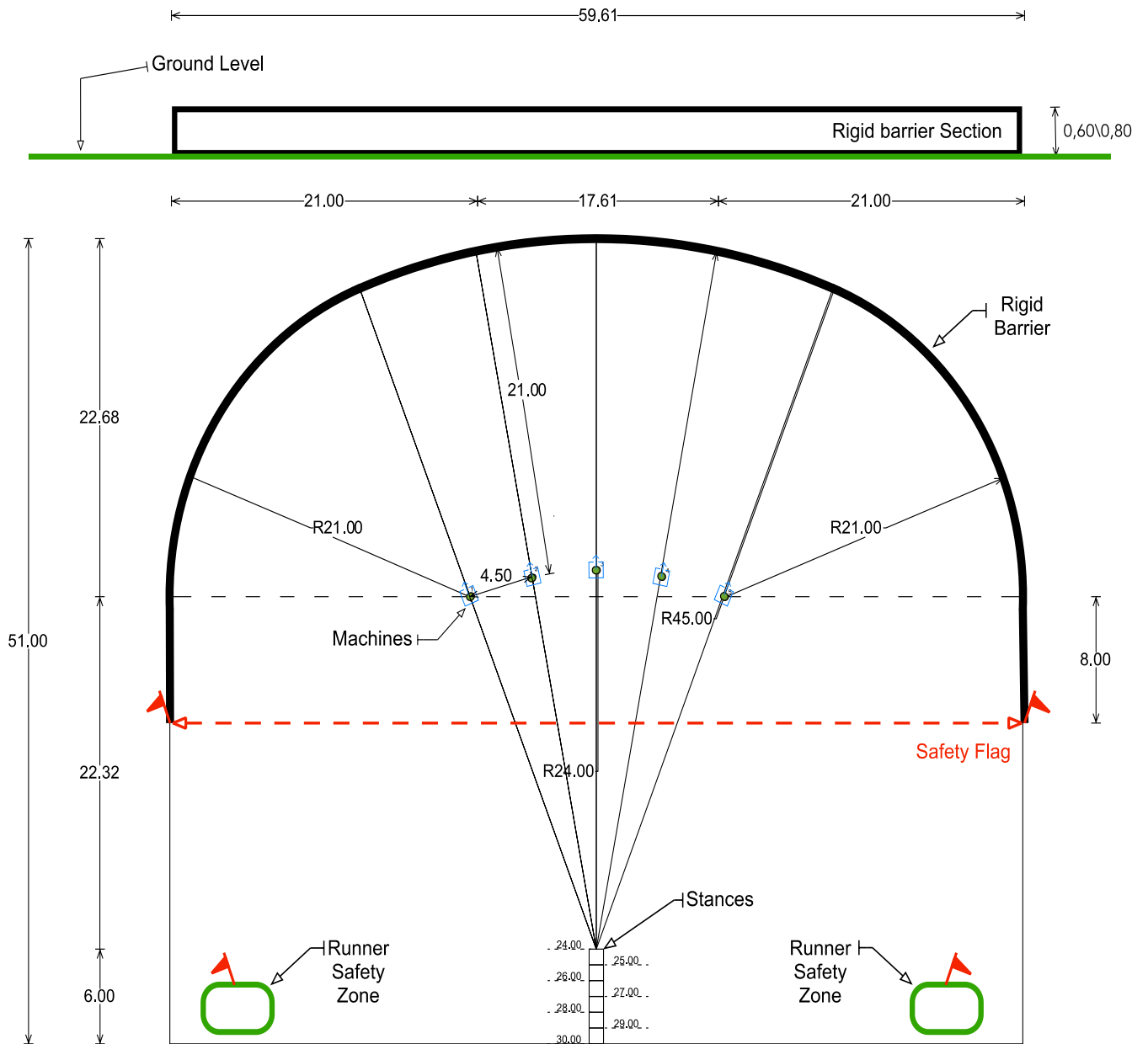

### 1.2.1 Machines characteristics, Chip Set and Sonopull

The machines must be mounted with a height from the ground between 40 and 50 cm from the highest point of the target release door. (see draw 1.2 A)

The target release door (Volé) must be coloured GREEN with the back WHITE (when the Volé is open must show white behind). The Volé dimensions must be from 20 to 35 cm of width and from 35 to 45 cm of height. (see draw 1.2 A).

The target's release in flight must occur within a delay of 0.30\0.50 sec from the opening angle of the vole at a 35° angle. (see draw 1.2 C).

They have to be supplied at the end of the axis of the carrier rotor with a launching slope called "BEC"

The speed of the motor, porter of the helices, must be able to be adjusted in a progressive manner from zero to 7.500 max. (rotation/minute).

The motor machine must have the possibility of being regulated with a height varying from 10° to 45 ° (see draw 1.2 B) with respect to the floor level and with an angle minimum of 30° and maximum of 45 ° from the left and right (see draw 1.2 D).

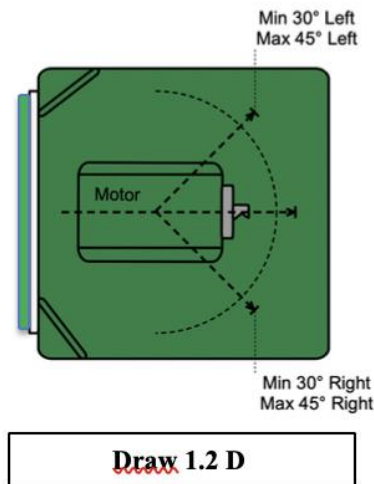
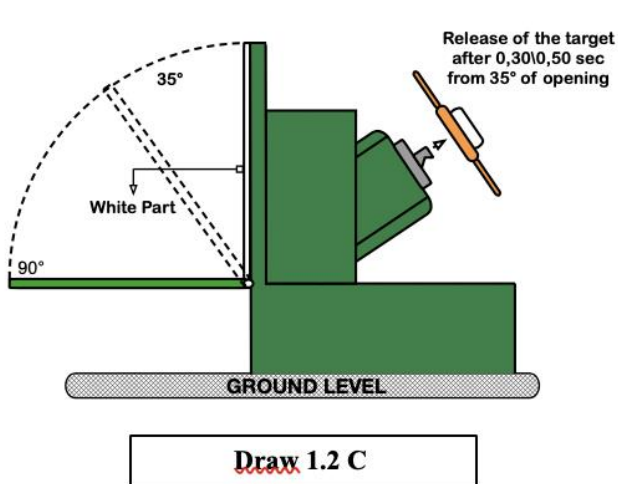
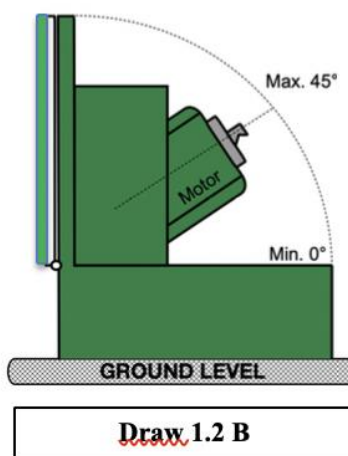
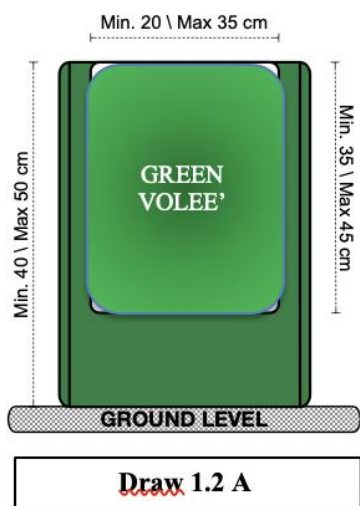

### 1.2.2 Control Unit

The machines need to be controlled by a Control unit (Draw 1.2 E) that, randomly, selects which target must be released. The Control Unit is controlling the Motors and the opening of the “White doors”.

Each Control Unit is linked with a Sonopull system that will activate with a voice command “PULL” from the shooters. This will give the input to release the targets.

The Control Unit needs to be accessible by the Referee who is controlling the “Time Limit” (See rules 6.5 and 6.6). When the Time Limit is over, the Control Unit must automatically stop the motors.

The Control Unit for the Referee must not have any control over the selected speed. This must be separate and is to be “sealed” during the competition phases.

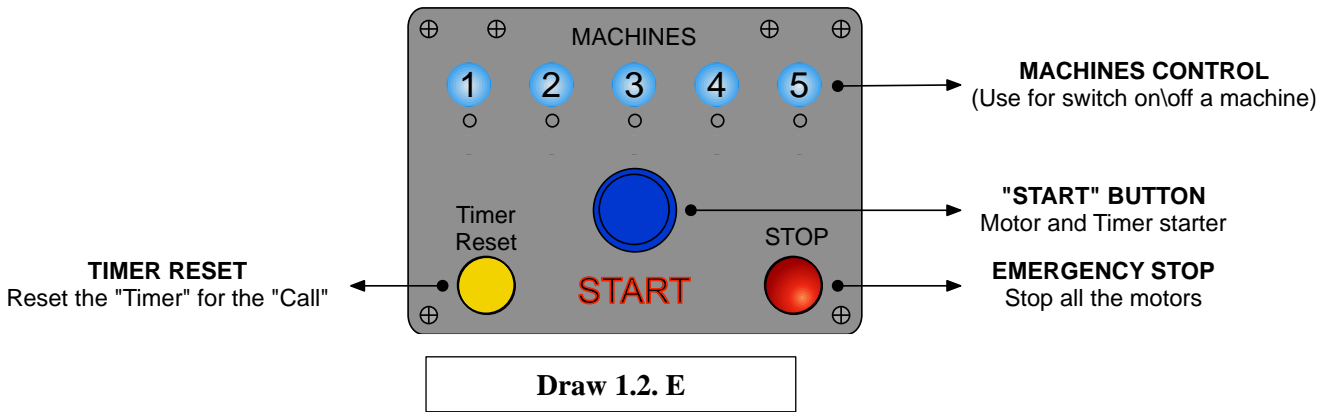

### 1.2.3 Sonopull

The Sonopull is furnished with a light blinking system that indicates the timing of the “Call” to the shooters. This light needs to be visible enough to help the shooters to “Call” the target in the time allowed. (See draw 1.2.F)

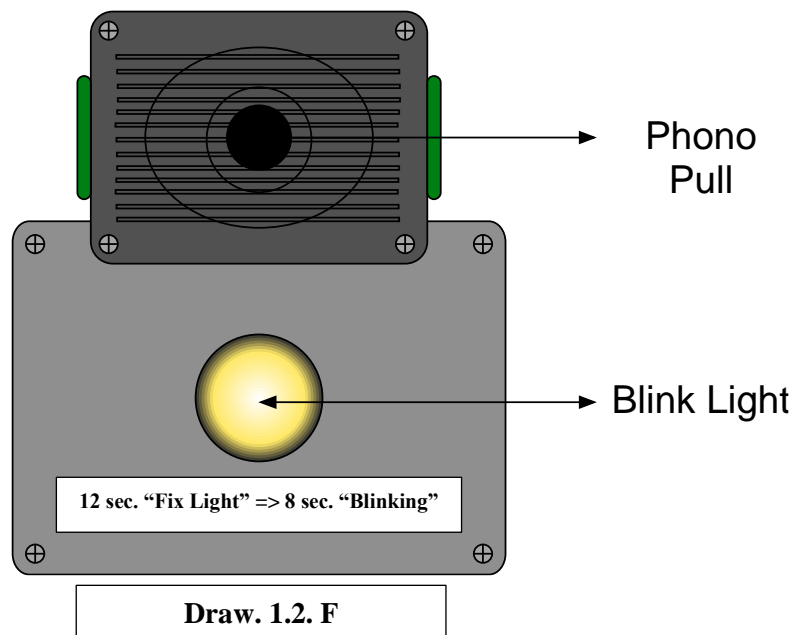

## 1.3 Helices

### 1.3.1 Homologated helice

Only homologated helices by Fitasc will be allowed to any Fitasc Competitions.

To obtain the homologation by the Fitasc Technical Committee, the producer must follow the following specifications and apply with a “formal request” to Fitasc.

Characteristics of the helices will have to be following:

- Size:**
- scale of the helice carrier 28 cm  $\pm$  0,5 cm
  - diameter of the White part 10,4 cm with a tolerance of  $\pm$  0,5 cm
  - the helice in substance may have 2 blades.
- Weight:**
- total of the helice: 60 grams with a tolerance of  $\pm$  5 grams
  - the white part :  $\pm$  25 grams with a tolerance of  $\pm$  3 grams
- Substance:** The helice in substance very friable to the shot impact (polystyrene)  
The white part not friable to the impact (minimum 50 % of polyethylene)
- System of fastener:**
- The system of fastener must be by “pressure”
  - The connection of the “white” with the “helice wing” must have an allowance to not lock the two parts. This allowance ensures the “white” is free to move on the horizontal plain.
- Color:**
- color of the helice “wings”: Orange
  - color of the target “white part”: White
- Upon decision of the Helice technical commission, the helice carrier or the witness can be of any different colour that would make it more visible. In any case, during a championship, only one colour for the helice carrier and only one for the witness will be used.
- Breakability:**
- The breakability of the helice is measured with a Shore Durometer (by pressure). The maximum deformation before the breakability is after 0,5 mm. The testing point is on the center of the collar of the wings part.

### PICTURE OF AN HELICE FRONT AND BACK



## 2 ORGANIZATION OF A COMPETITION

### 2.1 Type of competitions

Two types of organization coexist:

- competition organized with a number set in advance of eliminatory 'zero',
- and competition organized with a fixed number of helices to be shot by each competitor.

The international championships will be shot, with no elimination, with the fixed number of helices as follows: 20 helices at Grand Prix / 30 helices at continental and world championships

For the Grand Prix, the Continental and World Championships, the shooting distance **is fixed at 26m.**

### 2.2 Entry fees

The entry fee will include:

- the fee allocated to the expenses of the club,
- the total number of helices shot by a participant in the championship, as well as the helices for shoot-off;
- the Fitasc shooter's fee.

### 2.3 Cash prizes

The federation applying to organize an international competition will be allowed, if wished so, to include in its program cash prizes, whose guaranteed amounts will be set by the federation in agreement with the organizing club.

When cash prizes have been authorized by the organizing federation and in agreement with the organizing club, they cannot be funded neither by shooters' entry fees nor by the organizing club. They will have to be strictly and exclusively funded by sponsoring operations or by side pot not obligatory for the shooters.

### 2.4 Numbers of Helices

The number of helices shot is set by the jury:

- During competitions or championships organized with 5 machines, the shooter will have to shoot between 1 and 4 helices without leaving the shooting stand.
- During competitions or championships organized with 7 machines, the shooter will have to shoot between 1 and 6 helices without leaving the shooting stand.
- During competitions or championships organized with 9 machines, the shooter will have to shoot between 1 and 8 helices without leaving the shooting stand.

Of course, the electronic system of the control box will have to allow the selection of machine opening. Upon jury decision, the maximum number of helices may be modified.

## **2.5 Testing guns**

Under no circumstances may guns be tested on the shooting stand of the competition. Before going onto a layout, shooters may, if they wish, test the operation of their guns on a stand specially designed and laid out for the purpose near the clubhouse. A shooter that will be found “dry firing” his gun out of these areas will be sanctioned with a “WARNING”. (Yellow Card)

## **2.6 Age limitation categories:**

The age limitations of categories in force are:

- Juniors (male or female) are authorised to take part in championships held under the auspices of the Fitasc from 1<sup>st</sup> January of the year when they reach their 13 years of age except in the case of a special waiver.
- Female junior can choose registration as junior or as Lady.
- Male juniors fall into category “man” from 1<sup>st</sup> January of the year when they reach their 21<sup>st</sup> birthday, regardless of the day and month of birth.
- Shooters in the category “man” become seniors from 1st January of the year when they reach their 56<sup>th</sup> birthday, regardless of the day and month of birth.
- Seniors become veterans from 1<sup>st</sup> January of the year when they reach their 66<sup>th</sup> birthday, regardless of the day and month of birth.
- Veterans become masters from 1<sup>st</sup> January of the year when they reach their 73<sup>rd</sup> birthday, regardless of the day and month of birth.

## **2.7 BIB number and Random Sort:**

All the shooters must get their BIB number before the start of the 1<sup>st</sup> day of the Competition (Grand Prix) after the random sort is done.

The second day of the competition the “starting number” is moved by 1/3 according to the number of participants.

The day after, the “starting number” is moved by 2/3 according to the number of participants.

Competitors are not allowed to shoot without a BIB number.

In case a shooter will not have his BIB number during the shooting procedure, he will be sanctioned by a “WARNING” (Yellow Card).

## **2.8. Individual shoot-off**

### **2.8.1 Shoot-off order**

Shooting order of all shoot-offs will be determined randomly.

#### **2.8.2.1 Grand Prix**

For the first three places and for all categories: 2 targets per shooter with elimination at first zero.



### **2.8.2.2 Continental Championship**

For the first three places and for all categories:

5 helices without elimination (2+2+1).

In case of new tie: the shooters will break the tie by shooting double on report between the machine 2 and the machine 4, with elimination at first zero.

### **2.8.2.3 World Championship**

1) For the first three places of the category OPEN:

10 helices without elimination.

In case of new tie: the shooters will break the tie by shooting double on report between the machine 2 and the machine 4, with elimination at first zero.

2) For the first three places of all OTHER categories:

5 helices without elimination (2+2+1).

In case of new tie: In case of new tie: the shooters will break the tie by shooting double on report between the machine 2 and the machine 4, with elimination at first zero.

Tied shooters without award will be ranked as equals.

## **2.9 Team competition:**

Only shooters taking part to the continental or world championship may be a member of their National team at the Match of National Teams.

### **2.9.1 Team Shoot-Off**

At the end of the shoot-off, if teams are tied, the tie will be broken as follows:

Each team captain decides the firing order of his shooters.

The shooters of each team take turns shooting a helice. With the same number of helices fired, the first shooter to score zero eliminates his/her team.

## **3 COMPETITION OFFICIAL**

### **3.1 General**

All persons who are designated to serve as officials in FITASC competitions must possess valid qualifications appropriate to the level of the competition.

### **3.2 Jury**

The championships will be run by a jury:

- Chaired by the Chairman of the organizing national federation or his/her representative.

- The attending members of the Fitasc Management Committee and of the Helice ZZ Technical Commission, as well as a representative from each country entering a National Team.
- The Chief referee.

The jury will settle any disputes arising during the competition regarding the organization of the shoot and of the shooters.

The President of the technical Commission is not member of the jury but attends all meetings and takes part in the debates.

The jury will decide, among other things, if the match of nations takes place during the championship or after on a separate trial, depending on the number of participants. The organization of the shoot-off will be defined by the jury.

On each championship, the jury shall fix between 1 and 4 maximum the number of helices shot by each competitor on each installation and without any machine reloading.

The jury will take into account:

- the number of days of the championship,
- the number of participants,
- the total number of helices shot by a participant,
- the daily shooting duration.

In case of force majeure, the jury may decide:

- To reduce the competition duration;
- To reduce the helice number of the competition.

### **3.2.1 Duties Before the Competition Starts**

Before the competition starts, the Jury must:

- a) Check the ranges to ensure that they comply with the current Rules;
- b) Ensure that targets are correctly set according to these Rules;
- c) Review the competition organization to confirm that it is prepared to conduct the competition.

### **3.2.2 Duties During the Competition**

During the competition, the Jury must:

- a) Supervise the competition;
- b) Advise and assist the Organizing Committee;
- c) Ensure the correct application of the shooting regulations;
- d) Check the athlete's gun, ammunition and equipment;
- e) Check that the targets are set correctly after a machine breakdown;
- f) Make random checks during Competition to ensure compliance with the rules concerning guns, ammunition, shooting vests and other clothing;
- g) Deal with protests that are properly submitted;
- h) Make decisions regarding penalties;
- i) Implement sanctions where appropriate and issue « WARNINGS »;

### **3.3 Coordinator**

The Coordinator of the Championship between the jury and the management is the President of the Technical Commission or his/her delegate.

#### **3.3.1 The Coordinator is responsible for:**

- a) Fulfilling all technical and logistic issues with regard to preparation and proper conduct of a competition; and
- b) Performing all duties listed below in close cooperation with the members of the technical Commission, Jury, Organizing Committee, and other staff members.
- c) He/she is responsible for enforcing the decisions made by the jury.

#### **3.4 The duties of the Coordinator are:**

- a) To give instruction and to supervise preparation of the shooting ranges according to technical and safety requirements as described in the FITASC Rules, relevant to the Helice championships events;
- b) To give instructions and supervise preparation of auxiliary facilities such as gun and ammunition storage, technical service, means of communication between the shooting ranges, technical personnel etc.;
- c) To give direction and supervise the preparation of helice targets for training and competition;
- d) To ensure that the helice machines are adjusted according to the settings of the day;
- e) To ensure that all necessary range systems are functioning properly;
- f) To ensure that all range equipment is on each range and properly placed (seats for Assistant
- g) Referees, facilities for the athletes etc.);
- h) To provide a metric scale which will weigh in decimals the shot charges and helice targets;
- i) To provide instruments to check the dimensions of targets and shot;
- j) To assist the Organizing Committee to prepare technical meetings for competition officials and team leaders;
- k) To make decisions, with the approval of the Jury, regarding change of competition times and range allocations and interruption of the shooting on the ranges, for safety or other reasons.

### **3.5 Chief of Referees**

The Chief of Referees must be appointed by the Fitasc Technical Commission of Helice ZZ. He/she must possess a FITASC international Helice ZZ Referee's license and must have a wide experience in Shotgun shooting, a thorough knowledge of shotguns and of the FITASC Rules applying to the competition.

#### **3.5.1 The duties of the Chief of Referees:**

The duties of the Chief of Referees, in general, are:

- a) To assist the Organizing Committee in the selection and appointment of the Referees;
- b) To supervise the Referees and Assistant Referees;

- c) To give instruction and information to the Referees and Assistant Referees;
- d) To prepare the schedules and assignments for the Referees;
- e) To make decisions in cooperation with the Jury, such as when and on which ranges an athlete who had to leave his/her position to repair a gun malfunction or was declared “ABSENT” may be permitted to complete his round;
- f) To keep the Coordinator informed of any difficulties, failures etc. on the ranges;

### **3.6 Referees**

Only official FITASC referees will be entitled to judge an international championship.

#### **3.6.1 Referees must be appointed by the Organizing Committee in cooperation with the Chief of Referees and must:**

- a) Possess a FITASC Helice ZZ Referee’s license;
- b) Have wide experience in Helice ZZ shooting;
- c) Have a knowledge of Shotgun and FITASC Helice ZZ Rules applying to the competition.

#### **3.6.2 Main functions of the Referee:**

The main functions of the Referee are:

- a) To check that the correct athlete is present on the range;
- b) To ensure that the correct procedure is used to declare an athlete “ABSENT” (see Rule 6.4 for “ABSENT” athlete);
- c) To make immediate decisions regarding HIT targets (in all doubtful cases or a disagreement made by the athlete, the Referee must consult with the Assistant Referees before making a final decision);
- d) Making a final decision);
- e) To make immediate decisions regarding LOST targets (the Referee must give a clear and distinct signal for all targets declared “LOST”);
- f) To make immediate decisions regarding “NO TARGETS” and IRREGULAR targets (if possible, the Referee must call “NO TARGET” or give some signal before the athlete fires);
- g) To issue « WARNINGS » or automatic « DEDUCTIONS » for rule violations where appropriate;
- h) To ensure that the result of each shot is correctly recorded;
- i) To ensure that the athletes are not disturbed;
- j) To rule on any protests received from an athlete;
- k) To rule on disabled guns;
- l) To rule on malfunctions;
- m) To ensure the correct conduct of the round;
- n) To ensure the application of the safety rules.

**Note: Irregular targets require an immediate decision by the Referee**

#### **3.6.3 Warnings Issued by the Referee**

- a) The Referee must give « WARNING » for rule violations (YELLOW CARD) and must note such warnings on the official range scorecard;

- b) The Referee may not assess penalties or disqualifications that fall under the responsibility of the Jury.

### **3.6.4 Referee decision**

Nobody can interfere with a Referee's decision. In case the shooter is not in agreement with his decision he can apply for a formal protest (see rule 3.9)

## **3.7 Assistant Referees**

Each range must have a minimum of 1 referee, who is responsible for taking care of all the shooting procedure and another one that is in this case an assistant.

### **3.7.1 Assistant Referees Rotation**

The Coordinator will set a way of rotation of the referees.

### **3.7.2 The main duties of an Assistant Referee are:**

- a) To watch each target thrown;
- b) To carefully observe whether a target is broken before the shot is fired;
- c) To give, immediately after a shot, a signal to the Referee if he/she observes that in his/her opinion the target(s) is/are "LOST;"
- d) If required, to mark the result of the Referee's decision regarding each shot on the official scorecard;
- e) If asked, to advise the Referee on any other matters relating to the targets;

## **3.8 Appeal Jury**

If a jury decision is disputed by a shooter or by the FITASC, an appeal jury will be formed by:

- the Chairman of the Fitasc or his/her representative;
- the Chairman of the technical commission or his/her representative;
- the Chairman of the affiliated federation or his/her representative.

This appeal jury will be created at the same time as the jury. No jury member may belong to the appeal jury under any circumstances.

## **3.9 Complaints of shooters:**

Complaints of shooters will have to be presented to the International Commission of helice ZZ shooting, on paper and to pay a security whose amount is fixed by the jury, and that will be returned if the complaint is judged based.

# **4 EQUIPMENT AND AMMUNITION**

## **4.1. Athletes Clothing and Accessories**

### **4.1.1 Clothing**

Competition participants must be properly dressed.

- a) Sports trousers, training (athletic warmup) trousers and jackets, for men and women and similar sports blouses, skirts/dresses for women are allowed;
- b) Open toe or open heeled shoes, sandals or any other similar footwear are not allowed;
- c) Shorts or skirts with the bottom of the leg not more than 15 cm above the center of the knee cap are allowed;
- d) Shirts, T-shirts and similar garments with sleeves less than 10 cm in length or without sleeves are not allowed.

Wearing sandals is not permitted for safety reasons.

A shooter's competition number must be fixed on their back between the shoulders and the waist and must be visible in its entirety.

Any breach of this rule will first be sanctioned by a "WARNING" from the referee. Failure to rectify their outfit will result in supplementary sanctions that can go as far as exclusion from the competition by decision of the jury.

At the closing ceremony, all the awarded shooters shall attend the prize giving, either in the attire of their National team, or wearing a pair of pressed trousers & blazer or a National Training suit/T-shirt.

#### **4.1.2 Hearing protection**

Hearing protection is compulsory for all shooters, referees, staff and members of the public on or in the proximity of a layout. Any shooter on a stand without hearing protection is considered absent (see Rule 6.4 for "ABSENT" athlete). In all circumstances outside the clubhouse, children present on a range must wear hearing protection.

#### **4.1.3 Safety glasses**

Safety glasses are compulsory, without any exceptions, for all shooters, referees, staff and anyone else in the immediate vicinity of a stand. Any shooter on a stand not wearing safety glasses is considered "Absent to the Call" (see Rule 6.4 for "ABSENT" athlete).

Safety glasses are to be complete of the protection glass and must be worn to protect the eyes.

#### **4.2. Shotguns**

All smooth barrelled hunting guns with a calibre that is no greater than calibre 12 and whose length is not less than 66cm (26 inches), are admissible, except pump action shotguns which are prohibited.

The release trigger is authorized provided that the shooter informs the referee before shooting.

Shooters using semi-automatic shotguns must equip them with a device that prevents their spent cartridges from disturbing the shooter beside them.

They must be charged with the maximum of two cartridges.

Straps and slings are prohibited on all guns.

Changing a gun, fully or partially, "mobile choke" or barrel is prohibited within the same round. It is authorised between rounds.

Any owner of a shotgun with a release trigger will affix, on the outer side of the buttstock, a sticker that sports a big "R" on a fluorescent background, as a warning.



## **4.3 Ammunitions**

### **4.3.1 Cartridge Specifications**

The cartridge shot load must not exceed 28 grams of lead with a maximum tolerance of +2%. Shot must be spherical, of a regular diameter of 2.5mm maximum with a tolerance of more or less 0.1mm.

- The use of dispersers, or any other unusual loading device is strictly forbidden, as is the use of reloaded cartridges.
- Mixing different shot of differing dimensions and/or qualities is strictly forbidden, as is the use of black powder and tracer cartridges.

### **4.3.2 Cartridge Inspection**

The Jury must implement a cartridge inspection program that is designed to cause minimal interference to the shooting or athletes during the competition:

- a) Jury Member may remove an unfired cartridge from the athlete's gun for inspection;
- b) A Jury member or the Referee may take an athlete's cartridges for inspection at anytime when the athlete is in the shooting area;
- c) If an athlete uses ammunition that is not in accordance with these rules he/she must be disqualified.

## **4.4 Sonopull**

The sonopull is set on the Line of the 26 mt. The shooter can move the sonopull in the horizontal direction of the 26 mt. line. Is forbidden move the sonopull passing the line of the 26 mt. In case the shooter will move in any other direction will be sanctioned with a “WARNING” (Yellow Card) by the referee.

## **4.5 Electronic Devices, Mobile and Cameras**

The use of micro cameras mounted on shotguns or any artificial aiming device is forbidden.

On the shooting position or in the areas nearby, a shooter cannot have with him (her) electric or electronic equipment such as mobile phones, likely to disturb the competitors.

# **5 MALFUNCTIONS**

## **5.1. Malfunction definition**

Failure of a properly loaded gun to fire when the trigger is pulled (mechanical failure or misfire), or a defective cartridge that does not deliver its full load when the primer was struck, or when

a single pull of the trigger or the involuntary operation of both triggers on a double trigger gun produces a simultaneous discharge, must be recorded on the scorecard as a MALFUNCTION.

## **5.2 Number of Malfunctions Permitted**

The athlete is permitted a maximum of three (3) malfunctions per round, whether or not he/she has changed his gun or ammunition. In case of a malfunction the referee will add on his/her score card the malfunction n° 1 and so on;

- a) All regular target(s) on which any additional malfunction of gun or ammunition occurs in the same round will be declared “LOST,” whether or not the athlete attempted to fire;
- b) If after a malfunction, the Referee agrees with the athlete that the gun is in need of repair, then action may be taken in accordance with the Rules for “Disabled Shotguns” (Rule 5.3)

### **5.2.1 Procedure in the Event of a Malfunction**

Decisions on malfunctions of either gun or cartridge must be made by the Referee.

#### **5.2.1.1 In the event of misfire due to any reason, the athlete must:**

- a) Keep the gun pointed at the target flight area;
- b) Not open the gun;
- c) Not touch the safety catch;
- d) Hand the gun safely to the Referee for examination if asked;
- e) Answer any questions from the Referee.

**Note: The athlete is responsible for checking the gun after it is returned by the Referee.**

#### **5.2.3. The following are not considered malfunctions:**

- a) Faulty manipulation of the mechanism by the athlete;
- b) Failure to place a cartridge in the correct chamber of the gun;
- c) Any fault attributable to the athlete.

### **5.2.4 Ammunition Malfunctions (Misfires)**

Decisions on ammunition malfunctions must be made by the Referee. The following are considered ammunition malfunctions when the firing pin indentation is clearly noticeable and:

- a) The powder charge is not ignited;
- b) Only the primer fires;
- c) The powder charge is omitted.

#### **5.2.4.1 Actions after Malfunctions of the ammunition Declared**

- a) In case the Referee will declare an “ammunition malfunction” of the first shot, the shooter must repeat the target with 2 shots.
- b) In case the Referee will declare an “ammunition malfunction” of the second shot, the first cartridge must be shot after the departure of the helice above the machines, but this one can be broken only by the second cartridge. If the helice is broken by the first cartridge, then it is definitely declared “ZERO”.



#### **5.2.4.2 Actions after Malfunctions of the gun are Declared**

- a) In case the Referee will declare a “gun malfunction” of the first shot, the shooter must repeat the target with 2 shots.
  
- b) In case the Referee will declare a “gun malfunction” of the second shot, the first cartridge must be shot after the departure of the helice above the machines, but this one can be broken only by the second cartridge. If the helice is broken by the first cartridge, then it is definitely declared “ZERO”.

If the Referee decides that the disabled gun or that the malfunctioning of the gun is not the fault of the athlete, and that the gun is not repairable quickly enough, the athlete may use another approved gun if it can be obtained within three (3) minutes after the gun has been declared “DISABLED.”

#### **5.3 Disabled Shotguns**

Decisions on disabled shotguns must be made by the Referee.

A shotgun may be considered disabled if:

- a) It cannot be fired;
- b) The athlete having already suffered two (2) malfunctions of either gun or ammunition in a round obtains permission from the Referee to change it;
- c) It fails to eject due to mechanical defect; or
- d) For any other reason that renders the gun unusable.

## **6 SHOOTING PROCEDURE**

### **6.1 Shooting procedure**

The shooter will have to stand on the shooting position and not outside, their feet will not have to exceed the line corresponding to its distance. The gun can be held in any position judged safe by the shooting manager, from the hunting position until the complete shouldering.

### **6.2 Load\unload a gun**

The shooter will have to load his/her gun only on the shooting position, the barrel directed toward the side of boxes and only when the staff have returned back to their place. He/she will have to unload his/her gun before turning toward the following shooter.

When a shooting position is fitted with a bin or a container for empty cartridges, the shooter must drop them off there. The shooters using semi-auto shotguns have to pick up their empty cases after leaving the shooting position and throw them in the bins if it is possible.

### **6.3 Shooting**

The helices must be shot in accordance with the order of ranges set by the jury. Any helice shot not in accordance with this order will be counted “ZERO”.

#### **6.4 Absent to the call**

Shooters that will not reply to the call of their name (three calls) on the first field of the Competition will be declared "ABSENT TO THE CALL" and will be sanctioned with the number of "ZERO" related on this turn of helice. (Example: Range A - 3 Helices to be shot = if absent 3 Zeros).

Nevertheless, this zero will be acquired only at the precise moment when the next shooter will have walked on the shooting stand.

#### **6.5 Shooting procedures with manual machines (Time limit)**

The sonopull must have a visual "light" system that warns the shooter of the beginning of the shooting procedure and the end. (see draw 1.2.D as sample).

When the shooter shows up on the shooting position and the workers that charge the machines "RUNNERS" are in a safety position, the referee presses the button that turns on the helice launchers and says "time" or "pronto" to warn him/her that the helices are launched. (The safety position of the "Runners" must be indicated with a "Safety Flag").

The shooter has 20 seconds to load and close his shotgun, and call the helice. Beyond this period, the micro will be cut and the helice counted as zero.

If the referee considers that the shooter has been disturbed by an external element that has delayed the command of the helice, then he may decide to give him a complete cycle of 20 seconds.

If the shooter is to shoot several helices in a row, as soon as the previous helice's score has been announced, the referee presses the button again to start the machines.

If the helice is thrown before the shooter order "PULL", he/she may refuse to shoot this helice. However, if he/she shoots this helice, the result will be recorded. The "timer limit" will be restarted.

#### **6.6 Shooting procedures with automatic machines (Time limit)**

The sonopull must have a visual "light" system that warns the shooter of the beginning of the shooting procedure and the end. (see draw 1.2.D as sample)

When the shooter shows up on the shooting position, the referee presses the button that turns on the helice launchers and says "time" or "pronto" to warn him/her that the helices are launched.

The shooter has 20 seconds to load and close his shotgun, and call the helice. Beyond this period, the micro will be cut and the helice counted as zero.

If the referee considers that the shooter has been disturbed by an external element that has delayed the command of the helice, then he may decide to give him a complete cycle of 20 seconds.

If the shooter is to shoot several helices in a row, as soon as the previous helice's score has been announced, the referee presses the button again to start the machines.

If the helice is thrown before the shooter order "PULL", he/she may refuse to shoot this helice. However, if he/she shoots this helice, the result will be recorded. The timer will be restarted

## 6.7 “GOOD” helice flying

All the helices that are flying are to be considered valid except for the following cases:

- a) An helice is flying broken or without the “WHITE” part attached;
- b) An helice passes behind the security flags;
- c) A target that is touching the floor without continuing to fly.

## 6.8 “GOOD” helice (acquired result)

To be considered as "good", the white part of the helice has to come off and fall in the enclosed area. If this part bounced outside, the helice is declared "GOOD".

To be declared good the white part of the helice must detach at the first or the second shot, and fall inside the enclosed area.

The two shots will have to be shot in the acceleration phase of the helice.

If the competitor in the case of a gun/cartridge malfunction, opens the gun him/herself or touches the safety catch, before the referee has checked the gun, the target(s) will be scored “ZERO”.

## 6.9 “NO BIRD” helice

Helice targets will be considered “NO BIRD” as follows:

- a) If there is a part of the helice broken or the white is not attached;
- b) If the two shots leave together;
- c) If two or more helices will fly together and the shooter “accepts” (agree to shoot) the result will be recorded;
- d) If the shooter has NOT fired when: a target is thrown before the shooters call;
- e) There is an allowable malfunction of the gun or cartridges; or
- f) The shooter’s first shot misfires due to an allowable malfunction of either gun or cartridge and he/she does not fire the second shot; If the second shot was fired, the result of that shot must be scored.

## 6.10 “ZERO” helice

An helice must be declared “ZERO” when: It is not hit during its flight and;

- a) The “white” is not fully detached from the helice in the enclosed area;
- b) An athlete, for no permitted reason, does not shoot at a regular target for which he/she has called;
- c) After a malfunction of gun or cartridge, an athlete opens the gun or moves the safety catch before the Referee has inspected the gun;
- d) An athlete suffers a third or subsequent malfunction of gun or cartridge in the same round;
- e) The first shot is a miss and the athlete fails to fire his/her second shot because he/she forgot to place a second cartridge in the gun, to release the stop on the magazine of a semi-automatic shotgun, or because the safety has slipped to the “safe” position by recoil of the first shot;
- f) The athlete is not able to fire his/her gun because he has not released the safety or has forgotten to load;
- g) The athlete's foot position is violated the line of 26 mt. and the athlete has been warned once already. **(Second Yellow Card)**

### **6.11. First shot not detached “white”**

If the helice is declared « NO BIRD » before the shooter has shot the first cartridge, he/she will shoot a new helice with two cartridges.

A helice missed at first shot (white part not detached) and which is declared “NO BIRD” before or during the second shot, give rise to a new helice shot with two cartridges.

The first cartridge must be shot after the departure of the helice above the machines, but this one can be broken only by the second cartridge. If the helice is broken by the first cartridge, then it is definitely declared “zero”.

### **6.12 Helices that leave together**

If several helices leave together, the shooter can refuse to shoot by raising his gun. If he/she shoots one helice and breaks it, it will be declared good, if he/she misses, it will be declared zero.

In any case the shooter must shoot on one helice only.

### **6.13 Helice out of the flags**

For safety reasons, every helice shot outside of the diagonal flag line is declared zero. Besides, a fine set by the jury will be inflicted to the shooter.

### **6.14 “Yellow card” procedures**

The referees have the possibility to issue "warnings" through the use of yellow cards. For each violation where the "warning" is provided, the Referee will note the violation and the violated rule on the athlete's scoresheet. For every 2 yellow cards the athlete will be sanctioned with a "Zero for Deduction".

### **6.15 “Zero for Deduction” procedures**

The "Zero for deduction" is imposed on an athlete who has received 2 "yellow" cards.

When an athlete receives a "Zero for deduction" he will have to shoot a target, hit it, and after a result acquired as "good" it will be declared "zero" for "deduction". In case the athlete misses the target this will be declared as "zero" and the "zero for deduction" will be applied to the next target declared as "good".

### **6.16 System with 1<sup>st</sup> release trigger and 2<sup>nd</sup> pull trigger (release–pull trigger)**

#### **6.16.1 First shot – no bird**

At first shot, in case of a “no-bird” target (announced by the referee), or for any other reason preventing the shooter from shooting, he/she must:

- Either keep the trigger pulled and call for a new target;
- or keep the trigger pulled and push the opening lever to the side in order to open the gun; for semi-automatic shotguns, apply the safety catch and pull the cocking handle to the rear twice to empty the chamber and magazine.
- or notify the referee, and fire the 1st shot in a safe direction indicated by the referee.

#### **6.16.2 Second shot – no bird**

After the shooter has fired his/her first shot and if the second target is “no bird”:the shotgun can be opened.

## **6.17 System with double release trigger**

### **6.17.1 First shot – no bird**

Same process as at 6.16.1

### **6.17.1 Second shot – no bird**

Same process as at 6.16.1

RULES ACCREDITED BY THE ORDINARY GENERAL ASSEMBLY DATED JULY 10<sup>th</sup> 2023.